

TOZO

Technology Surrounds You



www.tozostore.com



LDAC

Qualcomm
aptX

ORIGX

knowles

TÜVRheinland

SLOGAN

Technology Surrounds You

MISSION

Provide Premium Products & Superior Services Worldwide

VISION

Being a Trusted Intelligent Technology Company

CONTENT

01	ABOUT US
03	BRAND STORY
04	PATENT CERTIFICATE
05	GLOBAL LAYOUT
06	MEDIA REPORTS
07	PRODUCT R&D
11	PRODUCT DESCRIPTION
65	QUALITY ASSURANCE
67	BRAND IMAGE & USER EXPERIENCE

ABOUT US

TOZO was established in Seattle

Supported by 16+ million users; Commented by 900,000+ customers.

TOZO is committed in research, develop and manufacture of high-tech digital products. Include wireless audio, smart IOT, virtual reality, and digital accessories.

TOZO is Powered by energenic R&D Team and world's top factories. Dedicated to produce best quality products by choosing high quality and healthy environment protection materials, shortening intermediate links and improving efficiency. In order to clients can get excellent products and extreme user experiences and green low-carbon life.



PROFESSIONAL TEAM

Possessing a good corporate culture, a sound corporate management system, core channel customers, innovative development strategies, a strong technical core and talent advantages have laid the foundation for our brand development. With keen market insight, we will definitely succeed in the market.



In the field of audio, TOZO takes "Technology Surrounds You" as its core product concept, to achieve the perfect integration of innovative technology and simple design, create comfortable wireless products involving ultimate experience, restore the purest sound of nature, and provide users with music Temple-like hearing enjoyment.

In the future, TOZO will not forget its original intention and use e-commerce or a broader platform as the medium to continue to work hard and create surprises in filed of technological product, technological research, development and user experience. Furthermore, we will continue to seek progress that meets the needs of users in order to create an unprecedented ultimate experience.

900,000+
customers

16,000,000+
Users

200+
Patents



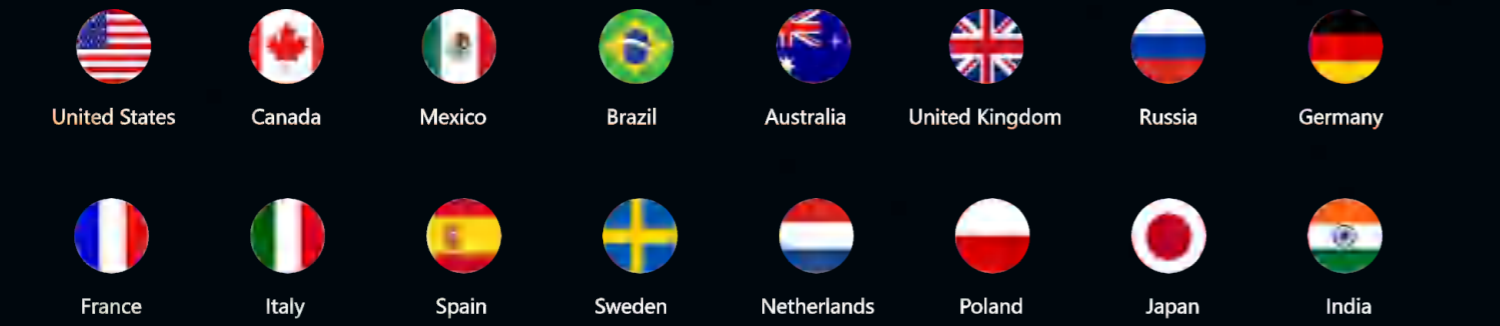
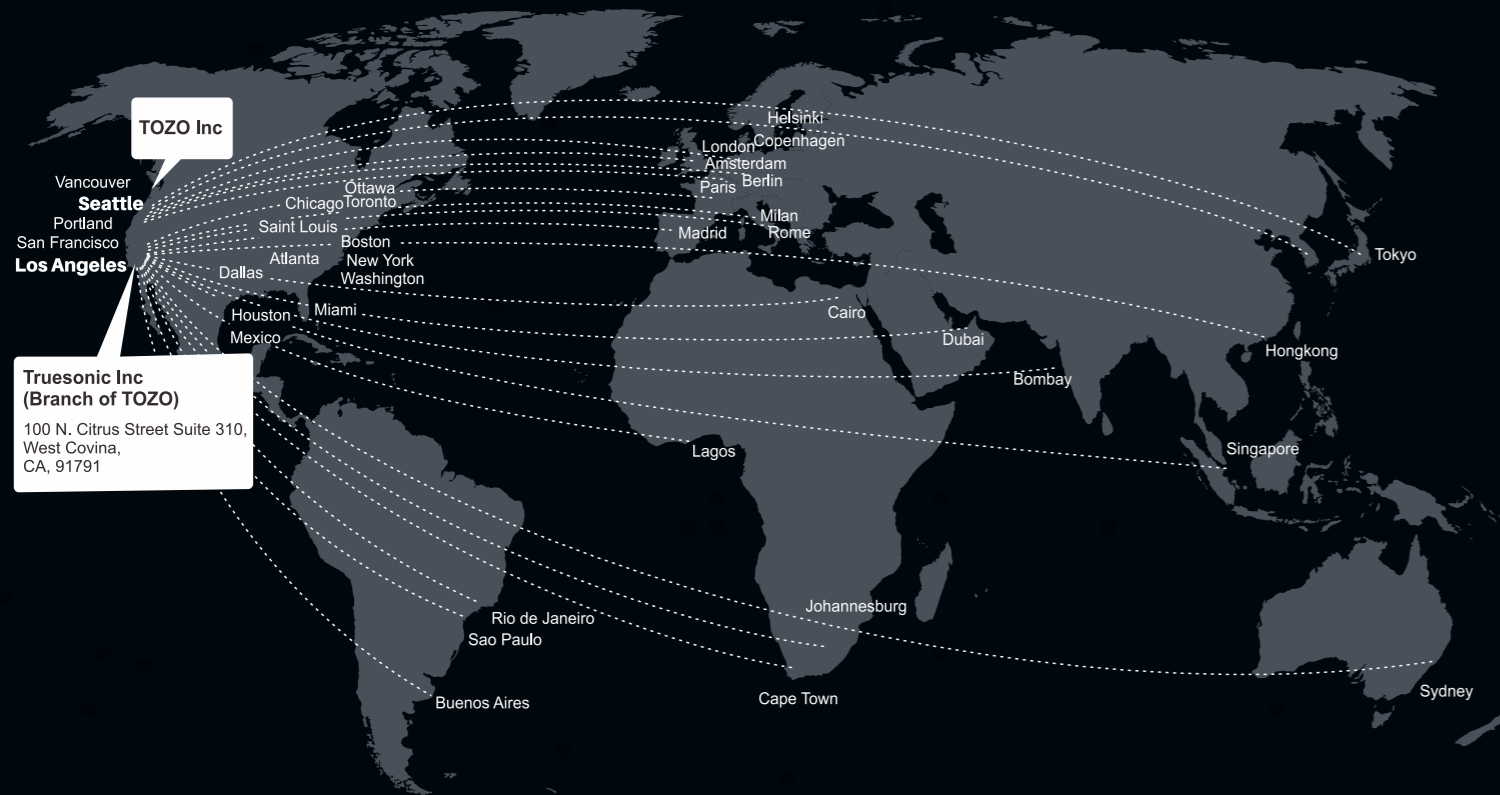

"The TOZO T6 are a decent pair of truly wireless headphones."

"The TOZO T10 are alright headphones for mixed usage. Their very portable design and impressive passive isolation performance make them a decent choice for commuting or using in the office."

"The TOZO T12 are a decent pair of budget-friendly truly wireless earbuds. "

"The TOZO NC9 Truly Wireless are well-built in-ears with an impressive ANC feature that can block out lots of background noises. "

"The best Bluetooth headset for calls at a budget-friendly price point that we've tested are the TOZO NC7 Truly Wireless. "

"The TOZO NC2 are well-built truly wireless headphones. "

RTINGS.com

"It sounds almost too good to be true. "

RollingStone

"And for earbuds that you could use while swimming laps, try a pair from TOZO. They make earbuds with an impressive IPX8 rating. "

BUSINESS INSIDER

"The TOZO T6 continue to impress me with how good they perform with a price this low. When it comes to a balance of features and price, the TOZO T6 are what stand out as being one of the strongest contenders out there. "

androidcentral
APPAREL

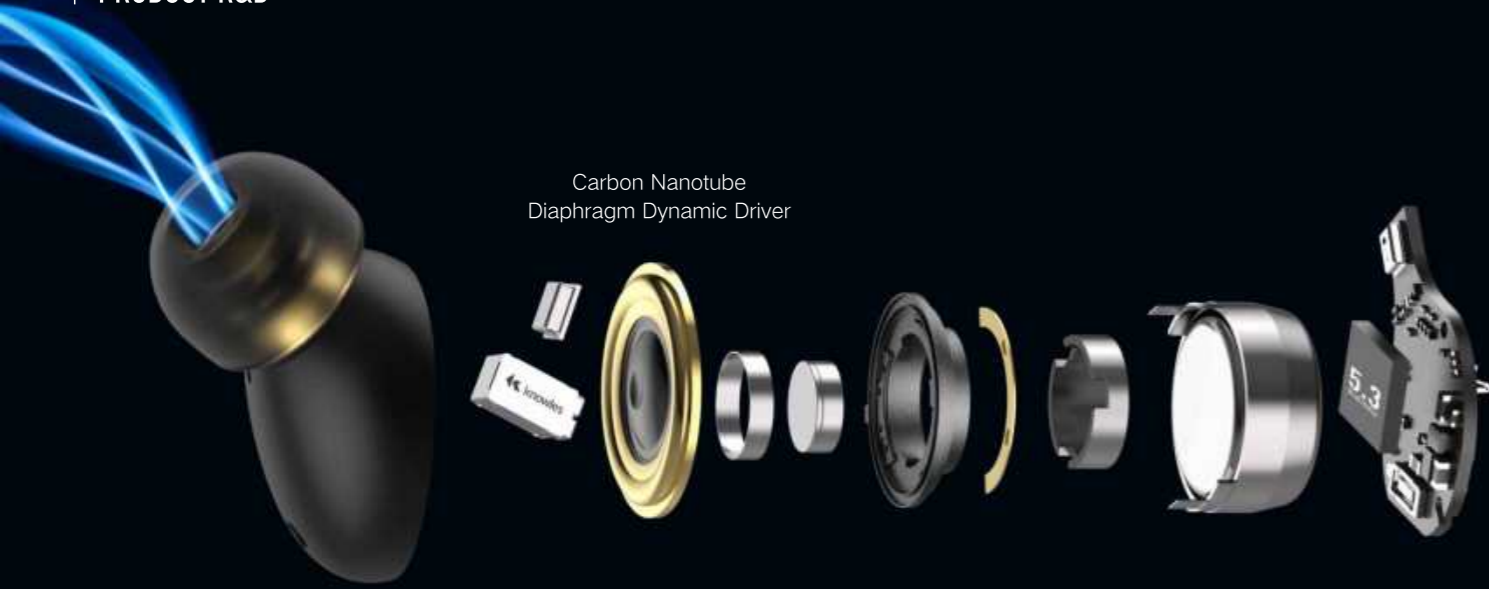

High Quality Wireless Music Listening Technology

From Sony's official data, LDAC HD data transmission is more than 3 times faster than SBC traditional Bluetooth coding technology, The maximum transmission speed is about 990kbps, which can enhance the wireless listening experience of music.

ORIGX Acoustic

TOZO research HI-FI digital, material and cavity acoustic technology that compensates for the frequency lost when the sound passes through the ear canal curve, keeping the sound that reaches the eardrum is closest to reality.

Custom Armature Driver Unit with Knowles

High sensitivity and high resolution moving Armature Driver can hear more sound details and present cinema level sound effects. 12mm super large Armature Driver is 90% larger than the traditional single armatured, with clear treble, soft and mellow midrange, powerful bass and transparent human voice.

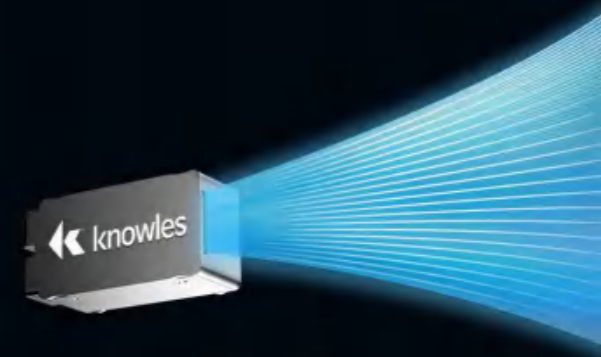

TOZO Golden X1

Make you a feeling of immersion

Real guitar sound can be so beautiful, TOZO Golden X1 with 12mm Dynamic Driver and Knowles Armature

Reproduce the music with clarity, precision and impact

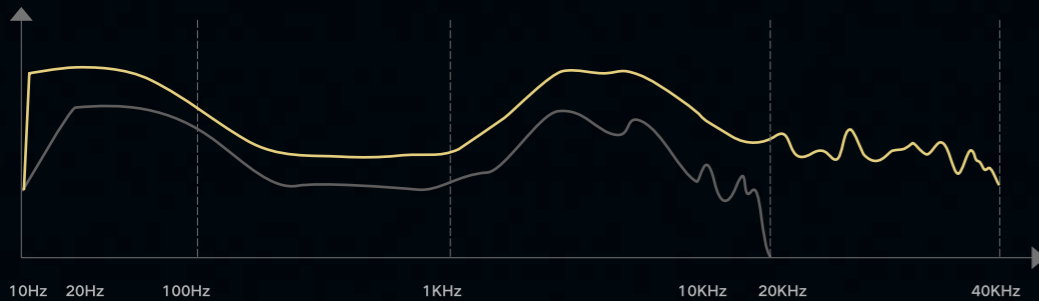

TOZO Golden X1 Sound effect

Normal Sound effect

Ultra-Long Battery Life

Up to 32 hours of listening time

8 hrs
Single charge

32 hrs
With charging case

500 mAh
Battery capacity







TOZO Golden X1

Balanced Armature Drivers and Dynamic Drivers
LDAC & Hi-Res audio wireless

 ANC Mode
Transparent Mode

 Dual
Microphone

 One-Step
Pairing

 Customized
Sound Settings

PRODUCT DESCRIPTION

COLOR



FEATURES

[Balanced Armature Drivers and Dynamic Drivers] The combination of precise dynamic driver creates powerful bass while a balanced armature driver provides crisp clear mids and highs for perfect clarity. The unique crossovers can provide higher sensitivity, lower distortion, and more detail on these true wireless earbuds.

[LDAC Technology & Hi-Res Audio Wireless] Support Hi-Res Audio Wireless gold label by JAS and LDAC certificated by SONY, enjoying the immersive sound quality of high resolution within the wireless scenarios.

[ANC&ENC Noise Cancellation] The Active Noise Cancellation (ANC) shields you from all noise outside the game, allowing you to immerse yourself in the communication and game environment with your teammates. At the same time Environmental Noise Cancellation (ENC) Technology with 6 mic built-in blocks out 80% of background noises and make your voice 3x times clearer on the other side.

[Bluetooth 5.3 & Long Distance Connection] With Bluetooth 5.3 technology and rod-shaped earphone has a connection distance of 15m, has superior sound quality and strong signal, so that there is no disconnection in listening to music or making phone calls.

[Large Battery Capacity & Smart LED Digital Display] Features with touch control sensors, TOZO Golden X1 earbuds can provide at least 32 hours of long battery life. In Wireless Charging case, the smart LED digital screen can check battery consumption display anytime.

BASIC PARAMETER

Support type: HFP / HSP / A2DP / AVRCP

Earbuds battery capacity: 55mAh × 2

Charging box battery capacity: 500mAh

Bluetooth version: 5.3

Charging time of earbuds: 1.5H

Call noise cancellation: 6-Mic hybrid ANC and ENC

Charging time of charging box: 2H

Frequency range: 12Hz~44.1kHz

Transmission distance: 15M





TOZO NC9 Pro

Active Noise Cancelling

Provide the sound of immersion

 ANC Mode
Transparent Mode

 Dual
Microphone

 One-Step
Pairing

 Customized
Sound Settings

PRODUCT DESCRIPTION

COLOR



FEATURES

[Active Noise Cancellation] Hybrid 3 layer Active Noise Cancellation.

1. Outward-facing microphone detects external sounds and counter with equal anti-noise to first cancel noise.
2. Inward-facing microphone listens inside ear canal to pick up internal sounds and produce anti-noise again to twice cancel the left noise.
3. Ear caps prevent 90% noise going to ear canal.

[Transparent Mode] You can hear what you want to hear, which lets outside sound in so you can hear and interact with the world around you. You can clearly hear the announcement of the airline or subway and what is being said around you without taking off the headphones.

[Built-in Dual Noise Cancelling Microphone] Double microphone noise reduction system suppresses environmental noise. A dedicated internal and two external microphones pick up your voice and isolate it from outside noise.

[One-step Pairing] Pick up the headsets from the charging case, and they will be paired automatically. Then simply enable bluetooth connection on your mobile phone to pair the device with your earbuds.

[Charge on the Go] TOZO NC9 Pro wireless earbuds can last for over 10.5 hours' play time from a single charge and 24 extra hours in the compact charging case. Providing convenient charging with no strings attached.

BASIC PARAMETER

Support type: A2DP/HFP/HSP/AVRCP

Mic noise reduction: 6-Mic hybrid ANC and ENC

Music play time: about 10.5 hours (ANC off)

Frequency range: 14Hz-20kHz

Phone call time: about 6 hours (ANC off)

Bluetooth version: 5.3

Earbuds battery capacity: 72mAh/3.7V*2

Charging box battery capacity: 500mAh/3.7V

Charging box input: 5V/0.5A





TOZO NC9 Pro Max

Active Noise Cancelling

Emergency portable charging device, Built-in 2500mAh high-capacity lithium battery

 ANC Mode
Transparent Mode

 Dual
Microphone

 One-Step
Pairing

 Customized
Sound Settings

COLOR



FEATURES

[Active Noise Cancellation] Hybrid 3 layer Active Noise Cancellation.

1. Outward-facing microphone detects external sounds and counters with equal anti-noise to first cancel noise.
2. The inward-facing microphone listens in the inner ear canal to pick up internal sounds and produce anti-noise again to cancel the left noise twice.
3. Ear caps prevent 90% noise going to ear canal.

[Transparent Mode] You can hear what you want to hear, which lets outside sound in so you can hear and interact with the world around you. You can clearly hear the announcement of the airline or subway and what is saying around you without taking off the headphones.

[High-capacity batteries] The built-in 2500mAh battery from charging case will charge automatically once the earbuds are put in. You get over 160 hours of standby time when earbuds are fully charged. In addition, the charging case can act as a power bank for charging cell phones and other USB devices.

[One-step Pairing] Pick up the two headsets from the charging case, and they will be paired automatically. Then simply enable bluetooth connection on your cellphone to pair the device with your earbuds.

[LED Power Display] TOZO NC9 Pro Max has long battery life with LED power display for charging case, which shows remaining power in percentage. Charging case presents its battery from 1% to 100%. So that you don't have to run out of power through the headphones.

BASIC PARAMETER

Support type: HSP/HFP/A2DP/AVRCP

Mic noise reduction: 6-Mic hybrid ANC and ENC

Music play time: about 10.5 hours (ANC off)

Frequency range: 14Hz-20kHz

Phone call time: about 6 hours (ANC off)

Bluetooth version: 5.3

Earbuds battery capacity: 72mAh/3.7V*2

Charging box battery capacity: 2500mAh/3.7V

Charging box output: 5V/1A



TOZO NC2 Pro

Active Noise Cancelling

6-MIC hybrid active noise cancellation & ENC for clear calls

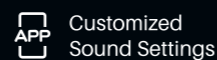
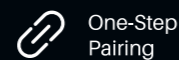
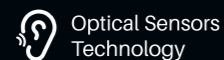
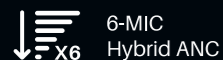

PRODUCT DESCRIPTION

COLOR



FEATURES

[Active Noise Cancellation] Hybrid 3 layer Active Noise Cancellation.

1. Outward-facing microphone detects external sounds and counter with equal anti-noise to reduce the environmental noise up to more than 35dB.
2. Inward-facing microphone listens inside ear canal to pick up internal sounds and produce anti-noise again to twice cancel the left noise.
3. Ear caps prevent 90% noise going to ear canal.

[Transparency Mode] You can hear what you want to hear, which lets outside sound in so you can hear and interact with the world around you. You can clearly hear the announcement of the airline or subway and what is saying around you without taking off the headphones.

[Optical Sensors Technology] Features optical sensors technology, they sense when they're in your ears and pause when you take them out. Adopt high-precision contact sensor, optimized for daily use and sports occasion, achieving real-time detection of wearing status.

[One-step Pairing] Pick up the two headsets from the charging case, and they will be paired automatically. Then simply enable bluetooth connection on your mobile phone to pair the device with your earbuds.

[Charge on the Go] TOZO NC2 Pro wireless earbuds can last for over 8 hours' playtime from a single charge and 32 extra hours in the compact charging case. Providing convenient charging way with no strings attached. IPX6 Waterproof can prevent from the damage of the splash by sweat and raindrops.

BASIC PARAMETER

Support type: HSP/HFP/A2DP/AVRCP

Mic noise reduction: 6-Mic hybrid ANC and ENC

Music play time : about 8 hours (ANC off)

Frequency range: 15Hz-20kHz

Phone call time: about 5 hours (ANC off)

Bluetooth version: 5.3

Earbuds battery capacity: 50mAh/3.7V*2

Charger battery pack: 500mAh/3.7V

Charging box input: 5V/0.5A



TOZO NC7 Pro

Active Noise Cancelling

Comfortable mini design



6-MIC
Hybrid ANC



Optical Sensors
Technology



One-Step
Pairing



Customized
Sound Settings

COLOR



FEATURES

[Active Noise Cancellation] Hybrid 3 layer Active Noise Cancellation.

1. Outward-facing microphone detects external sounds and counter with equal anti-noise to first cancel noise.
2. Inward-facing microphone listens inside ear canal to pick up internal sounds and produce anti-noise again to twice cancel the left noise.
3. Ear caps prevent 90% noise going to ear canal.

[Transparency Mode] With the transparency mode, you can hear what you want to hear, which lets outside sound in so you can hear and interact with the world around you. You can clearly hear the announcement of the airline or subway and what is saying around you without taking off the headphones.

[Built-in Dual Noise Cancelling Microphone] Double microphone noise reduction system suppresses environmental noise. A dedicated internal and two external microphones pick up your voice and isolate it from outside noise.

[Optical Sensors Technology] Features optical sensors technology, they sense when they're in your ears and pause when you take them out. Adopt high-precision contact sensor, optimized for daily use and sports occasion, achieving real-time detection of wearing status.

[Charge on the Go] Playtime lasts for over 10.5 hours from single charge and total 32 hours with charging case. Enjoy fast charging, to fully charge the rechargeable case only 1.8 hours via fast charge USB-C cable or less than 2.5 hours via wireless charger. Providing convenient charging way with no strings attached.

BASIC PARAMETER

Support type: HSP/HFP/A2DP/AVRCP

Mic noise reduction: 6-Mic hybrid ANC and ENC

Music play time: about 10.5 hours (ANC off)

Frequency range: 17Hz-20kHz

Phone call time: about 6 hours (ANC off)

Bluetooth version: 5.3

Earbuds battery capacity: 70mAh/3.7V*2

Charger battery pack: 500mAh/3.8V

Charging box input: 5V/0.5A



TOZO T6S

Hassle - Free Listening

IPX8 waterproof, super lightweight design

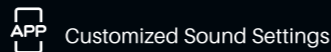
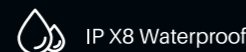
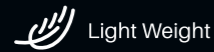

PRODUCT DESCRIPTION

COLOR



FEATURES

[Smart Touch Control] Accurate touch control function makes it more convenient to use, tap once to play/pause music and answer calls, double tap to skip forward/backward, hold to adjust the volume. You can easily control it without operating the phone.

[BLUETOOTH 5.3] Adopt the advanced Bluetooth 5.3 technology. TOZO T6S supports HSP, HFP, A2DP, AVRCP, which greatly improve the transmission speed and provide you with a low-latency listening experience.

[One Step Pairing] Pick up the 2 headsets from charging case and they will connect each other automatically, then only one step easily enter mobile phone Bluetooth setting to pair with the earbuds.

[IPX8 Waterproof] Earbuds and charging case inner Nano-coating make it possible to waterproof for 1 meters deep for 30 minutes. It is suitable for sports to prevent water. Ideal for sweating it out at the gym. Earbuds and case even can be washed by water and soap.

[Charge on the Go] Playtime lasts for over 10 hours from single charge and total 45 hours with charging case. Enjoy fast charging, to fully charge the rechargeable case only 55 minutes via cable or less than 2 hours via wireless charger. Providing convenient charging with no strings attached.

BASIC PARAMETER

Support type: A2DP/HFP/HSP/AVRCP

Frequency range: 15Hz - 20kHz

Music play time: about 10 hours

Phone call time: about 5 hours

Earbuds battery capacity: 55mAh/3.7V*2

Waterproof : IPX8

Charging battery pack: 600mAh/3.6V

Charging box input: 5V/0.5A

Transmission distance: 12M+



45ms low-latency



Game/ Music mode



10mm Moving coil unit



Smart touch



One step pairing



Customized Sound Settings

TOZO Gaming Pods

45ms Low-latency Designed for Gaming Players

More than 3 times faster response with regular Bluetooth earbuds

PRODUCT DESCRIPTION

COLOR



FEATURES

[45ms Ultra Low Latency] TOZO Gaming Pods wireless earbuds are built to provide the ultimate mobile gaming audio experience with an ultra-low 45ms latency. Designed for gaming adventures, offers ideal gaming audio so you never miss any game sound effects. Get ready for an exceptional competitive gaming experience through quick sound effect audio.

[Ultra-fast Bluetooth Connection] TOZO Gaming Pods can automatically connect to the Bluetooth of mobile phone when the headset charging box is turned on, avoiding complicated operations and saving waiting time. The 50ms Ultra Low-Latency is more than 3 times faster than conventional Bluetooth headsets, specially designed for gamers.

[Game & Music Dual Mode] Game/music sensitive switch, in the game mode can accurately capture the sound of footsteps/gunfire/car, quickly kill the enemy in the combat. The headset has a breathing light, allowing you to be more immersed in the game scene and double the gaming experience.

[Ultra-long Gaming & Standby Time] The battery life of TOZO Gaming Pods in the game state is more than 6h, and the battery life in the charging box can reach 30h, which makes the game experience more comfortable.

[Lightweight Headphones] The single earphone of TOZO Gaming Pods is only 4g, and there is not foreign body sensation in wearing with Ergonomic design, makes you feel more comfortable even when wearing headphones for a long time.

BASIC PARAMETER

Support type: HFP / HSP / A2DP / AVRCP

Earbuds battery capacity: 45mAh × 2

Charging box battery capacity: 500mAh

Bluetooth version: 5.3

Music play time: about 6 hours

Low Latency timing: 45ms

Charging time of charging box: 2H

Frequency range: 16Hz~20kHz

Transmission distance: 12M+

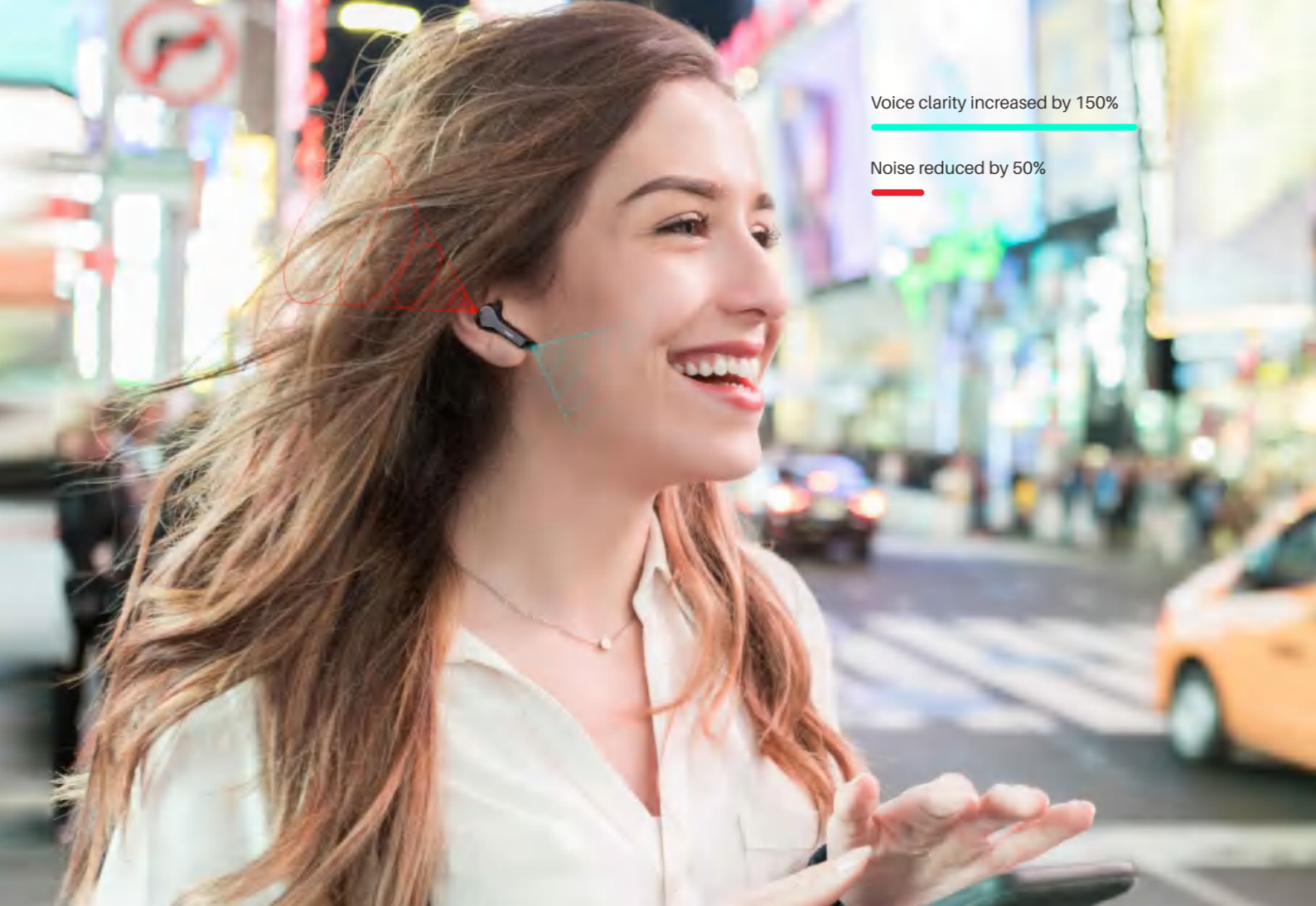

Voice clarity increased by 150%

Noise reduced by 50%

TOZO T9S

4 MIC and ENC Noise Reduction Design

Effectively attenuate the ambient noise during the call, delivering the calls with perfect clarity and maximum noise cancellation of 45db.

- Hi-Fi Stereo
- Environmental Noise Cancellation
- Touch Controls
- Customized Sound Settings

PRODUCT DESCRIPTION

COLOR



FEATURES

[ENC Call Noise Cancellation&Crystal-Clear Calls] TOZO T9S Earbuds featuring 8.0mm diameter speaker with crystal clear treble, 4 microphones deliver up to 3 times clearer calls than other truly wireless earbuds, reproducing your music vividly.

[Stereo & Immersive Sound Quality] Adopt the advanced Bluetooth 5.3 technology. With 3D immersive stereo surrounding sound, high bass balance. Strong signal, smooth connection when talking and listening to music, TOZO T9S Support HSP, HFP, A2DP, AVRCP, which greatly improve the transmission speed and providing you with a low-latency listening experience.

[IPX7 Waterproof] IPX7 water and sweat resistant Waterproof nano coating is adopted to effortlessly protect the earbuds from heavy rain or sweat during intense workouts and all-weather conditions.

[Tiny Size and Secure Fit Design] Mini and comfortable earbud design, secure fit all shape of ears, so 100% safe and stable while running, biking, training, jogging, hiking, exercising Gym Exercise and so on.

[Long Endurance] TOZO T9S earbuds lasts 8 hours for normal use on a single charge. Quick charging technology enables 1.5 hours of listening from just 10 minutes of charge. The powerful battery allow for all day listening, which gives you excellent experience of long endurance.

BASIC PARAMETER

Support type: A2DP/HFP/HSP/AVRCP
 Earbuds battery capacity: 55mAh × 2
 Charging box battery capacity: 350mAh

Bluetooth version: 5.3
 Charging time of earbuds: 1.5H
 Charging time of charging box: 1.5H

Frequency range: 16Hz~20kHz
 Music play time: 8.5H
 Phone call time: 5H



TOZO T10S

Fashionable Design Hassle-free Listening

Realize your instant enjoy of music

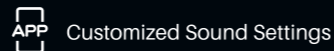
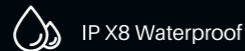
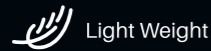
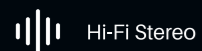

PRODUCT DESCRIPTION

COLOR



FEATURES

- [Stereo Sound Quality]** TOZO T10S Earbuds' 8mm large size speaker driver (the drive area is 1.77 times than the normal drive area) delivers powerful bass, mellow midrange, and clear treble (up to 20KHz). Reproducing your music vividly.
- [BLUETOOTH 5.3]** Features with the advanced Bluetooth 5.3 technology, TOZO T10S Earbuds support HSP HFP A2DP AVRCP, which provides instant pairing and stable transmission without interruptions.
- [One Step Pairing]** Simply take the 2 headsets out from the charging case, and they will connect each other automatically and then only one step easily enter mobile phone Bluetooth setting to pair with the earbuds.
- [IPX8 Waterproof]** Earbuds and charging case inner Nano-coating makes it possible to waterproof for 1 meters deep for 30 minutes. Waterproof and sweatproof latest technology can effectively prevent from the damage of the splash by sweat and raindrops.
- [Charge on the Go]** Playtime lasts for over 10 hours from single charge and total 45 hours with charging case. Enjoy fast charging, to fully charge the rechargeable case only 1.5 hours via fast charge USB-C cable or less than 2 hours via wireless charger. Providing convenient charging with no strings attached.

BASIC PARAMETER

Support type: A2DP/HFP/HSP/AVRCP	Phone call time : about 5 hours	Charging battery pack: 600mAh/3.7V
Frequency range: 16Hz - 20kHz	Earbuds battery capacity : 55mAh/3.7V*2	Charging box input: 5V/0.5A
Music play time: about 10 hours	Waterproof : IPX8	Transmission distance: 12M+



TOZO T12

High Sound Quality

Enjoy amazing sound quality

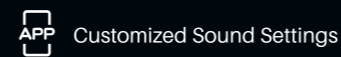
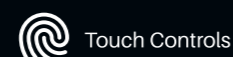
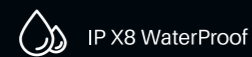
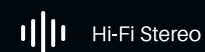

PRODUCT DESCRIPTION

COLOR



FEATURES

[Bluetooth 5.3 Technology & Easy Pairing] Featuring the most advanced Bluetooth 5.3 technology, TOZO T12 supports HSP, HFP, A2DP, AVRCP. Pick up the two headsets from the charging case and they will pair automatically, then in one easy step you can access your phone's Bluetooth settings to pair the earbuds, thus providing stereo sound during calls. Also boasts fast and stable transmission without tangling.

[Touch Control and Smart LED Digital Display] TOZO T12 headphones feature touch control sensors that reduce the pressure on your ears to a great extent when you touch the buttons for various functions. With wireless charging, the smart LED digital screen allows you to check the battery consumption display at any time.

[Comfortable to Wear, Fidelity Stereo Sound Quality] TOZO T12 wireless earbuds feature a curved in-ear design with silicone ear hooks to hold wireless Bluetooth headphones in place even during activity. TOZO T12 delivers truly natural, authentic sound and powerful bass performance with large 10mm speaker drivers - 2.77 times the drive area of normal drivers.

[IPX8 Waterproof] The nano coating inside the earbuds and charging case makes it waterproof to a depth of 1m for 30 minutes. It is suitable for sports to protect against water. Perfect for use in the gym when you get sweaty. Even the earbuds and base can be cleaned.

[Charging on the Go] Lasts over 8 hours on a single charge and up to 34 hours with the charging case. Enjoy fast charging, fully charging the rechargeable case in just 1.5 hours via a fast charging USB-C cable or less than 2 hours via a wireless charger. Offers convenient charging with no strings attached.

BASIC PARAMETER

Support Type: A2DP/HFP/HSP/AVRCP

Frequency range: 14Hz - 20kHz

Music play time: about 8 hours

Phone call time: about 5 hours

Earbuds battery capacity: 50mAh/3.7V*2

Waterproof : IPX8

Charging box battery capacity: 500mAh/3.7V

Charging box input: 5V/0.5A

Transmission distance: 12M+



Qualcomm®
aptX™



TOZO T12 Pro

Qualcomm aptX High Quality Sound

Emergency portable charging device

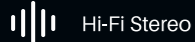

Hi-Fi Stereo



IP X8 Waterproof



Touch Controls



Customized Sound Settings

COLOR



FEATURES

[Equipped with Qualcomm QCC3040 Chip] Using the latest advanced Qualcomm 3040 chip, which supports APTX Stereo sound quality, CVC 8.0 active noise reduction, equipped with advanced audio DSP processor and audio algorithm, so that the treble is sweet and clear, the bass is strong, comparable to high-end headphones.

[Charge on The Go with 2500mAh Total 160 Hrs] The charging box comes with a wireless charging function, With 18650 battery capacity of 2500mAh, which can provide at least 160 hours of long battery life; The digital display shows the power at any time. What more, the charging box also supports Type-C interface charging input and USB 2.0 interface output Emergency charge for other equipment.

[Qualcomm CVC 8.0 Call Noise Reduction] CVC is an advanced call noise reduction technology that can filter environmental sounds and echoes to enhance our good experience when speaking and listening. When making a call, CVC will create a quiet environment for clear calls. The two-way transmission microphone noise reduction software separates our voice from the environment.

[IPX8 Waterproof & Touch Control] Earbuds and charging case inner Nano-coating makes it possible to waterproof for 1 meters deep for 30 minutes. It is suitable for sports to prevent water. Ideal for sweating it out at the gym, Even Wash the earbuds and base. Features with touch control sensors, TOZO T12 Pro Headset can largely minimize the pressure to your ears when you touch the button for various functions.

[aptX High Quality Sound] The earbuds can fully represent the original sound and perform a powerful and wide sound range with 10mm diameters large speaker and true wireless Bluetooth, delivering clear highs and deep bass comparable to the effect of Premium headset.

BASIC PARAMETER

Support Type: A2DP/HFP/HSP/AVRCP

Frequency range: 14Hz - 20kHz

Music play time: about 8 hours

Phone call time: about 5 hours

Earbuds battery capacity: 50mAh/3.7V*2

Waterproof : IPX8

Charging box battery capacity: 2500mAh/3.7V

Charging box input: 5V/1A

Transmission distance: 12M+



TOZO Crystal Buds

Transparent and Acrylic Style Special Design

Smart LED digital display with playtime

- Hi-Fi Stereo
- Environmental Noise Cancellation
- Touch Controls
- APP Customized Sound Settings

PRODUCT DESCRIPTION

COLOR



FEATURES

[Technology & Digital Display] The earphone charging box is made of fully transparent materials in a transparent design style with digital display, which can intuitively reflect the remaining power in real time, full of technological design.

[Call Noise Cancellation] TOZO Crystal Buds supports dual-mic AI algorithm call noise reduction, making calls more effective, allowing you to talk in public or outdoors without being affected by noise, and communicate clearly to ensure call quality.

[Bluetooth 5.3 & High-quality Sound] Equipped with Bluetooth 5.3 chip and true wireless Bluetooth technology, so the connection between TOZO Crystal Buds and other devices is very stable; Meanwhile, with 6mm diameter loud speaker, the original sound is a perfect recovery, making the treble sweet and clear, the bass is strong and powerful.

[IPX7 Waterproof] IPX7 water and sweat resistant Waterproof nano coating is adopted to effortlessly protect the earbuds from heavy rain or sweat during intense workouts and all-weather conditions.

[Long Endurance] TOZO Crystal Buds support wireless charging. The earbuds on a full charge can meet 7.5 hours while listening volume 50%; With large battery charging box, earbuds and charging box can achieve total endurance of more than 30 hours.

BASIC PARAMETER

Support type: A2DP/HFP/HSP/AVRCP	Bluetooth version: 5.3	Frequency range: 18Hz~20kHz
Earbuds battery capacity: 50mAh × 2	Charging time of earbuds: 1.5H	Music play time: 8H
Charging box battery capacity: 470mAh	Charging time of charging box: 2H	Phone call time: 5H



TOZO Tonal Pods

Long Battery Life, Enjoy Music Time

Enjoy listening moments

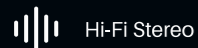

IP X8 Waterproof

Touch Controls

APP Customized Sound Settings

COLOR



FEATURES

[Long Battery Life] TOZO Tonal Pods earphones has 55mah high-capacity endurance capacity, and 50% of the listening volume can lasts10 hours; Equipped with 520mah large battery charging box, it can be charged for 4 times. The total endurance of headset + charging bin is more than 40 hours.

[ENC with Dual Mic Call Noise Reduction] TOZO Tonal Pods Bluetooth headphones dual microphone built-in equipped the latest moving-coil Horn loudspeaker with bigger dynamic driver, it has Hi-Fi sound quality, Deep bass and 3D surround stereo, provide you with more realistic call sound and reproducing your music vividly.

[Smart LED Digital Display and Support Wireless Charge] The smart LED digital screen can check battery consumption display anytime. Support wireless charging, easy to place, easy to take away, arbitrary, easy to display the power of headset and charging box at any time.

[Stereo & Reality Sound Quality] TOZO Tonal Pods featuring 8.0mm diameter speaker and Equipped the latest moving-coil Horn loudspeaker with bigger dynamic driver. It has Hi-Fi sound quality, deep bass and immerse stereo, make you feel like you are listening the concert on the scene, with providing a natural sound for you.

[Latest Bluetooth 5.3 Technology] True wireless earbuds Bluetooth 5.3 are equipped with the most advanced Bluetooth 5.3 chip, which provides more stable connection, faster paring and universal compatibility.

BASIC PARAMETER

Support type: A2DP/HFP/HSP/AVRCP

Frequency range: 17Hz - 20kHz

Music play time: about 8 hours

Phone call time: about 5 hours

Earbuds battery capacity: 57mAH/3.85V*2

Charging time of charging box: 1.5H

Charging box battery capacity: 500mAh/3.7V

Charging box input: 5V/0.5A

Transmission distance: 12M+



TOZO Agile Dots

Ultra Lightweight Design

Only 3.7g weight for a single earbud, feel nothing in hand

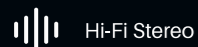

Hi-Fi Stereo



Light Weight



Sweatproof

COLOR



FEATURES

[Ultra Lightweight and Compact] The surface and Angle of TOZO Agile Dots earbuds in-ear part have been polished and refined repeatedly to achieve a balance between beauty and comfort and make it comfortable to wear, Likewise, a single earbud weighs only 3.7g, making it as light as a feather and discreet in the ear. Ergonomic design provides a comfortable and secure fit that doesn't protrude from your ears.

[Stereo Sound Quality] TOZO Agile Dots earbuds' 6mm diameter speaker presents a powerful and wide sound range, which makes the treble full of dynamics, and the bass powerful. Adopt advanced Bluetooth chip makes the sound played by the earphones much more beautiful and pleasant, suitable for sports or home work

[Smart Touch Control] TOZO Agile Dots earbuds supports dual ear touch control, providing convenient operation on volume control, previous/next song, pause and answer calls as well as voice assistant control.

[Bluetooth 5.3 & Long Distance Connection] With Bluetooth 5.3 technology TOZO Agile Dots has superior sound quality and strong signal, so that there is no disconnection in listening music or making phone calls within 12 meters.

[Long Endurance] With headphone 40mAh capacity and charging bin 400mAh capacity. The earbud lasts 8 hours for normal use, and the charging case lasts 32 hours for 3 times, which gives you excellent experience of long endurance.

BASIC PARAMETER

Support type: HFP / GAVDP / A2DP / AVRCP

Earbuds battery capacity: 40mAh × 2

Charging box battery capacity: 400mAh

Bluetooth version: 5.3

Charging time of earbuds: 2H

Earbud weight : 3.7g

Charging time of charging box: 2H

Frequency range: 20Hz~20KHz

Transmission distance: 12M



TOZO Agile Pods

Super mini, Light as Nothing

Feel the music rather than earbud with one touch,
turn on a pleasant listening experience

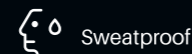
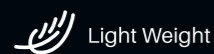
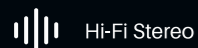

COLOR



FEATURES

[Ultra Lightweight and Mini Design] The surface and Angle of TOZO Agile Pods earbuds in-ear part have been polished and refined repeatedly to achieve a balance between beauty and comfort and make it stability to wear. A single earbud weighs only 3.9g, making it as light as a feather and discreet in the ear.

[Stereo Sound Quality] TOZO Agile Pods earbuds' 7mm diameter speaker presents a powerful and wide sound range, which offers a truly authentic sound and powerful bass performance. Adopt advanced Bluetooth chip makes the sound played by the earphones much more beautiful and pleasant, suitable for sports or home work.

[Smart Touch Control] TOZO Agile Pods earbuds supports dual ear touch control, providing convenient operation on volume control, previous/next song, pause and answer calls along as well as voice assistant control.

[Bluetooth 5.3 & Long Distance Connection] With Bluetooth 5.3 technology TOZO Agile Pods has superior sound quality and strong signal, so that there is no disconnection in listening music or making phone calls within 15 meters.

[Long Battery Life] With headphone 30mAh capacity and charging bin 315mAh capacity, The earbud lasts 6 hours for normal use, and the charging case lasts 30 hours for charges, which gives you excellent experience of long endurance.

BASIC PARAMETER

Support type: HFP / GAVDP / A2DP / AVRCP

Earbuds battery capacity: 30mAh × 2

Charging box battery capacity: 315mAh

Bluetooth version: 5.3

Charging time of earbuds: 1.5H

Earbud weight : 3.9g

Charging time of charging box: 1.5H

Frequency range: 20Hz~20kHz

Transmission distance: 12M+



TOZO Agile Fits

Ergonomic Half-in-Ear Design

Outstanding semi-in ear design, less pressure on your ear canal for optimum snug fit and comfort

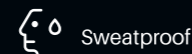
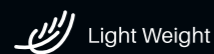
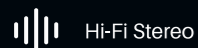

COLOR



FEATURES

[Charging Case with Reset Button] The charging case of TOZO Agile Fits is equipped with a reset button. When you want to clear the existing paired device data of the headset, you only need to put the headset into the charging compartment and press and hold the reset button on the charging box for about 10 seconds to clear the paired device data of the headset; There is no need to clear the data from the paired device, you can re-pair the headset to the device you want.

[Digital Call Noise Reduction] Equipped with the call noise reduction function that high-end headphones have, intelligently personalize noise reduction and sound performance for your ears, allowing you to enjoy deep, immersive sound, enabling you to communicate better when using headphones to communicate, avoiding loud sound brings bad call effect.

[Long Lasting Battery] TOZO Agile Fits earbuds lasts 5.5 hours for normal use (50% volume) on a single charge, quick charging technology enables 1.5 hours of listening from just 10 minutes of charge, headphones + charging compartment can last up to 22 hours. the powerful battery allow for all day listening, which gives you excellent experience of long endurance.

[Advanced Bluetooth 5.3 Technology & One-Step Pairing] TOZO wireless earbuds provide faster and more stable bluetooth 5.3 connection, this newest generation of bluetooth technology offers a strong, continuous connection as long as you' re within 30 feet of the paired device, and with one-step quick pairing, wireless earbuds will connect to the last paired device automatically with case opening.

[Ergonomic Design And Lightweight] TOZO earbuds' structure is the study of thousands of people's ear canal before design, comes with three different sizes of ear tips, which fit for most people's ear. These wireless bluetooth headphones are small and light, single earbud is only 3.3g, it' s more convenient to carry.

BASIC PARAMETER

Support type: HFP / GAVDP / A2DP / AVRCP

Earbuds battery capacity: 35mAh × 2

Charging box battery capacity: 400mAh

Bluetooth version: 5.3

Charging time of earbuds: 1.5H

Earbud weight : 3.3g

Charging time of charging box: 1.5H

Frequency range: 20Hz~20kHz

Transmission distance: 10M+



Anybuds Pro

Active Noise Cancellation, Immersive Music Anywhere

 ANC Mode
Transparent Mode

 Dual
Microphone

 8+25
Long Battery Life &
Fast Charging

COLOR



FEATURES

[Hybrid ANC Noise Cancellation] Hybrid active noise cancellation dynamically blocks out unwanted external low-frequency noise up to 99% (35dB). By eliminating distractions and letting music takes centerstage, Anybuds Pro lights your passion for music.

[Dual Mics ENC Call Noise Reduction] With dual mics to capture voice accurately and help reduce the background noise to such a large degree, your voice will be crystal clear at the other end when making a call.

[Comfortable and Secure Fit] With three pairs of silicone eartips (S, M, L) to fit a wider range of ears and provide all-day comfort. The eartips create an optimal acoustic seal to help keep out noise and secure earbuds in place.

[Long Battery Life & Fast Charging] Every single earbud can be used individually or together for 8 hours of playtime, and with the charging case, it extends to total 25 hours of playtime. It only takes less than 90 minutes to fully charge the battery case with the charging cable or the wireless charger.

[Bluetooth 5.3] With latest Bluetooth 5.3 technology Anybuds Fits has superior sound quality, connection reliability, energy efficiency and user experience.

BASIC PARAMETER

Support type: HFP / GAVDP / A2DP / AVRCP

Earbuds battery capacity: 40mAh × 2

Charging box battery capacity: 400mAh

Charging time of charging box: 1.5H

Music play time: about 25 hours

Transmission distance: 10M+

Bluetooth version: 5.3

Driver unit: Φ10mm

Standby time: 120h



Anybuds Fits

Half-in-Ear Design, Any Music at Anytime



13mm Large
Dynamic Driver



The Earbud
Weighs Only 2.9g



ENC Superior Call
Quality

COLOR



FEATURES

[Fantastic Sound with 13mm Dynamic Driver] Anybuds Fits powered by a premium 13mm dynamic driver, much larger than 8-11mm of most earbuds in market, enabling powerful bass and fantastic mids coupling for amazing sound quality, reproducing different rhythms and beats of music detail you love.

[Ergonomic Half-In-ear Design] The semi in-ear design has good clearance and eliminate sensation of ear pressure, If you feel uncomfortable wearing in-ear earbuds, this semi-in-ear headphones will be the perfect alternatives.

[Ultra Lightweight and Compatible for Small Ear] The surface and Angle of Anybuds Fits earbuds have been polished and refined to achieve a balance between beauty and comfort. The earbud weighs only 2.9g, making it as light as a feather and discreet in the ear. Ergonomic design provides a comfortable and secure fit that doesn't drop from your ears especially for Sports, Exercise, Gym, etc.

[ENC Superior Call Quality] With ENC technology, the earbud effectively block the environment noise out and make your voice clearer. The caller on the other side can clearly hear your voice even in a noisy environment.

[Bluetooth 5.3] With latest Bluetooth 5.3 technology Anybuds Fits has superior sound quality, connection reliability, energy efficiency and user experience.

BASIC PARAMETER

Support type: HFP / GAVDP / A2DP / AVRCP

Earbuds battery capacity: 35mAh × 2

Charging box battery capacity: 320mAh

Charging time of charging box: ≤2H

Music play time: about 24 hours

Transmission distance: 8M+

Bluetooth version: 5.3

Driver unit: Φ13mm

Earbud weight: 2.9g



TOZO S2

Call Function

Compatible for voice call with features such as dial/answer/mute and reject calls as long as the smart phone is nearby and connected to the watch.



Sports



Heart rate



Sleep



SpO2

PRODUCT DESCRIPTION

COLOR



FEATURES

[1.83 inches Large HD Color Touch Screen] 1.83 large color screen and full screen touch and hand sliding. it ensures smooth operations and 240*284 resolution for you. Our screen is better at color saturation and reproduction. Personalize your smart watch for men women with multiple customized watch faces provided, make your own stylish smart watch.

[Heart Rate, Sleep, Blood & Activity Tracking] With our smart watch, it accurately monitors your heart rate in real time. Also, it provides a detailed analysis of your sleep quality by continuously recording your sleep patterns. During exercise, TOZO smart watch automatically records daily steps, distance counter, calories burned, active minutes, measure your blood oxygen saturation and understand your physical state.

[Bluetooth Connectivity and Compatibility] When the S2 smart watch is connected to the app through Bluetooth, you can control the music player, view the local weather today, and support the mobile search function. TOZO smart watch is compatible with most iOS, Android or Bluetooth smartphones. Go to App Store or Google Play to download and install "TOZO Health" for free, then connecting our smart watch to your phone and start your journey of smart life.

[Long-lasting Battery Life & IP68 Waterproof] The large battery capacity (300mAh) and low power consumption design offers longer endurance. It can support 7 days of battery life when using the real-time heart rate function. TOZO smart watch is designed with IP68 waterproof rating(50m waterproof), so no need to worry when you wear it while swimming or sweating out.

BASIC PARAMETER

Waterproof level:

IP68 waterproof (50M deep water)

Product dimensions: 1.83 inch

Display resolution: IPS240 * 284

Screen technology: Multi-sport modes

Sleep tracking: 24 hours activity tracking

Batteries: 300mAh large capacity battery

Standby Time: waiting time 30 heavens



TOZO S2 Mini

Amazon Alexa Built -In

Use Amazon Alexa built - in to check the Weather, set reminders, start an exercise and do more from your smart watch.

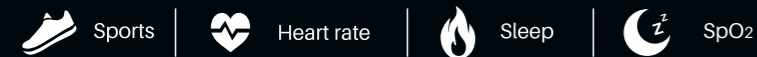

Amazon, Alexa and all related marks are trademarks of Amazon.com, Inc. or its affiliates. Alexa is not available in all languages and countries. Alexa features and functionality may vary by location.

PRODUCT DESCRIPTION

COLOR



FEATURES

[Alexa Built-in] Talk to Amazon Alexa on your TOZO S2 Mini. Ask questions, play music, check the weather, set alarms and timers, and more just by speaking to your watch. Also, you can speak to your smart watch via the built-in microphone upon the connection to your phone via Bluetooth.

[1.50 inches Large HD Color Touch Screen] 1.69 large color screen and full screen touch and hand sliding. it ensures smooth operations and 240*280 resolution for you. Our screen is better at color saturation and reproduction. Personalize your smart watch for men women with multiple customized watch faces provided, make your own stylish smart watch.

[Heart Rate, Sleep, Blood & Activity Tracking] With our smart watch, it accurately monitors your heart rate in real time. Also, it provides a detailed analysis of your sleep quality by continuously recording your sleep patterns. During exercise, TOZO smart watch automatically records daily steps, distance counter , calories burned, active minutes, measure your blood oxygen saturation and understand your physical state.

[Bluetooth Connectivity and Compatibility] When the TOZO S2 Mini smart watch is connected to the app through Bluetooth, you can control the music player, view the local weather today, and support the mobile search function. TOZO smart watch is compatible with most iOS, Android or Bluetooth smartphones. Go to App Store or Google Play to download and install "TOZO Fit" for free, then connecting our smart watch to your phone and start your journey of smart life.

[Long-lasting Battery Life & 5ATM Waterproof] The large battery capacity (300mAh) and low power consumption design offers longer endurance. It can support 7 days of battery life when using the real-time heart rate function. TOZO smart watch is designed with 5ATM waterproof rating(50m waterproof), so no need to worry when you wear it while swimming or sweating out.

BASIC PARAMETER

Waterproof level:
5ATM waterproof (50M deep water)

Product dimensions: 1.50 inch
Display resolution: IPS240 * 280
Screen technology: multi-sport Modes

Sleep tracking: 24 hours activity tracking
Batteries: 240mAh large capacity battery
Standby Time: waiting time 30 heavens



TOZO PA1

67mm Large Dynamic Driver

Excellent Audio 20W of Power by 67mm large dynamic driver pumps out great detailed mids, crisp treble, and especially enhanced bass at any volume

-  Hi-Fi Stereo
-  IPX7 Waterproof
-  One-Step Pairing
-  APP Customized Sound Settings

COLOR



FEATURES

- [Stereo Sound Quality & Dual Pairing]** TOZO PA1 speaker achieves dual pairing function, supports connecting two devices at the same time. Providing superior 2.0 stereo sound quality with 67mm diameter speaker, delivers exceptional boosted bass through powerful and wide Sound range.
- [EQ Mode Switch & App Connection]** TOZO APP offers PA1 speaker quick and easy access to app connection and customize eq mode switch, Where you have multiple choice to eq mode adjustment.
- [Large Capacity]** TOZO PA1 speaker lasts 12 hours for normal use at any volume on a single charge, the powerful battery enables all day Listening, which gives you excellent experience of long endurance.
- [Call Function]** TOZO PA1 speaker support call function, and you can take conference calls or friend group chats and access your device' s Default voice assistant right from the bluetooth speaker.
- [IPX7 Waterproof]** With IPX7 waterproof function, the PA1 speaker can work against the gentle splash of water or rain, providing strong.

BASIC PARAMETER

<p>Support type: A2DP/HFP/HSP/AVRCP</p> <p>Frequency range: 55Hz - 18kHz</p> <p>Music play time: about 12 hours</p>	<p>Waterproof level: IPX7</p> <p>Calling: 1 Mic</p> <p>Charging time: ≤2.5H</p>	<p>Battery specifications: 4000mAh/3.7V</p> <p>Signal to noise ratio: ≥80dB</p> <p>Transmission distance: 10M+</p>
---	---	--

COLOR



FEATURES

[Earth-friendly Packaging] Eco-friendly packaging TOZO is committed to a more sustainable, earth-friendly packaging. The packaged in a recyclable paper-based box, including the inner tray.

[IPX7 Waterproof] IPX7 waterproof and dustproof to the pool. To the park. TOZO PA2 is IPX7 waterproof and dustproof, so you can bring your speaker anywhere.

[4000mAh Battery Capacity] 12 Hours of playtime don't sweat the small stuff like charging your battery. TOZO PA2 gives you up to 12 hours of playtime on a single charge.

[Double Dynamic Drivers Unit Audio Output] Double dynamic drivers unit audio output. Big-sounding yet easy to carry, the design fits any personal style. Stand it vertical or horizontal and choose from a variety of vibrant colors.

[Two Speakers Can be Connected at the Same Time] It can link multiple TOZO Party Boost-compatible speakers to truly pump up your party.

BASIC PARAMETER

Support type: A2DP/HFP/HSP/AVRCP

Frequency range: 65Hz - 19.5KHz

Music play time: about 12 hours

Waterproof level: IPX7

Calling: 1 Mic

Charging time: ≤2.5H

Battery specifications: 4000mAh/3.7V

Signal to noise ratio: ≥83dB

Transmission distance: 10M+



TOZO PA2

Portable Sports Wireless Bluetooth Small Speaker

12 hours of long-lasting battery life, music is always around you

Hi-Fi Stereo

IPX7 Waterproof

One-Step Pairing

APP Customized Sound Settings



TOZO HT1

40mm Diameter Dynamic Driver Unit
and High Quality Sound Effects

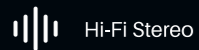

Hi-Fi Stereo



One-Step Pairing



Customized Sound Settings

COLOR



FEATURES

- [500mAh Battery Capacity]** A long-lasting battery capacity for 500mAh, Non-stop music playing for up to 40 hours.
- [Support APP, EQ Adjustment and Ather Functions]** Support a new TOZO APP to set your voice requirement, EQ and other functions.
- [It Can be Stored and Easily Carried]** Stretch the headband and adjust the most suitable size.
- [Bluetooth Version 5.3]** The aggressive Bluetooth Version 5.3.
- [40mm Diameter Dynamic Drivers]** Feature 40mm dynamic drivers with the high-quality sound effects.
- [With Active Noise Cancelling]** Active Noise Cancelling Bluetooth Over-Ear Headphone.

BASIC PARAMETER

Support type: A2DP/HFP/HSP/AVRCP

Frequency range: 20Hz - 44.1KHz

Music play time: about 41 hours

Talking Noise Reduction: 1 Mic ENC

Charging time: \leq 2H

Battery Capacity: 500mAh

Speaker impedance: 16 Ω

Transmission distance: 10M+

COLOR



FEATURES

[Open-Ear Design] Enjoy balanced audio, optimal volume and rich bass delivered through your cheekbone by using ENC noise canceling model. Ergonomic open-ear design will not go in or cover your ears, which allows you to listen to the surrounding sounds while enjoying music, offering a bud-free, pain-free wear for your all-day listening.

[IPX5 Waterproof Rated] Completely sweat and waterproof for workouts, fitness and running. Moisture detection alert included for safe charging. (Not suitable for swimming)

[Outstanding Sound Quality] Bone conduction technology uses vibrations to transmit sound through your cheekbone directly to your inner ear for a premium audio experience.

[Versatile Connectivity] Bluetooth 5.3 chip offers multi-point pairing compatible with your iOS and Android devices. The built-in microphones allow you communicate with others smoothly during calls and games. Compatible with smartphones, tablets.

[Single touch + physical buttons] Control your playlist without reaching both of buttons; Skip songs, launch music and answer calls simply by tapping your buds, so you can stay in the moment.

[10 Hours of Music & Calls] Enjoy eight continuous hours of music, calls and podcasts with our Bluetooth headphones. TOZO OPEN EAR also features a 10-minute quick charge for up to 2 hours of battery life. (Quick Charge Version of TOZO APP)

BASIC PARAMETER

Support type: A2DP/HFP/HSP/AVRCP

Frequency range: 20Hz - 20kHz

Music play time: about 8 hours

Waterproof level: IPX5(Speaker), IPX7(Mainboard)

Talking Noise Reduction: 2 Mic ENC

Charging time: ≤2H

Battery Capacity: 120mAh

Speaker impedance: 22Ω

Transmission distance: 10M+



TOZO OA1

Open Ear Design

Meet a criterion of the ergonomic design

Hi-Fi Stereo

One-Step Pairing

Customized Sound Settings

IPX7 Waterproof

COLOR



FEATURES

[High-Efficiency USB C Wall Charger] Powerful 20W PD output for exhilarating charging speeds. Moreover, just taking one PD cable, compatible with iPhone 12/13 series back to 50% in as quickly as 27 minutes.

[High Speed Charging] Fast Charging saves your more time on charging you phone, you don't have to worry about your phone in low battery. (Note: Cable is not included).

[Safe & Reliable] Built-in over-charging, over-heating and short-circuit to protect your devices against excessive current. Maximum dual safety provide you safety experience.

[Portable and Compact] Lightweight and compact design perfectly fits in you pocket to ensure maximum portability wherever you go. Efficient charging at home, in the office, or on the go.

[Highly Compatible] The USB-C charger is compatible with iPhone 14 / iPhone 14 Pro / iPhone 14 Plus / iPhone 14 Pro Max / iPhone 13 / iPhone 13 Pro / iPhone 13 Pro Max / iPhone 12 / iPhone 12 Pro / iPhone 12 Mini / iPhone 12 Pro Max / iPhone 11 / iPhone 8 and later, iPad mini5/ iPad Air3/iPad Pro and Samsung Galaxy and More.

BASIC PARAMETER

Input: 100-240V~50/60Hz 0.5A
USB-C Output: 5V=3A, 9V=2.22A, 12V= 1.67A

Size: 31.7*31.7*33.9mm
Weight: 35g

Material: Fireproof PC
Connector type: USB Type C

TOZO C1

PD 20W USB-C Charger

Maximum saving your time to gain the effective lifestyle



TOZO C2

65W USB-C Wall Charger

Fits into any space at your power sockets

COLOR



FEATURES

[High-Efficiency with Multi USB Port Wall Charger] Powerful 65W PD output for exhilarating charging speeds. You can charge 4 devices simultaneously and conveniently.

[High Speed Charging] Fast charging saves your more time on charging your phone, you don't have to worry about your phone in low battery. (Note: Cable is not included).

[Multiple Protection & Reliable] Built-in over-charging, over-heating and short-circuit to protect your devices against excessive current. Maximum dual safety provide you safety experience.

[Portable and Compact] Foldable design save space to ensure maximum portability wherever you go. Efficient charging at home, in the office, or on the go.

[Highly Compatible] The Charger is compatible with Steam Deck/Laptops/Tablets/iPhone 14/14 Pro/14 Pro Max/13/12/Mini/ Pro/Pro Max/XS/XS Max/XR/X/11/11 Pro/11 Pro max/8 Plus/8/7/6; Samsung Galaxy S Series/Note Series; LG V60/V50/G8/G7; Google Pixel Series; MacBook Air; MacBook Pro/MacBook/iPad Pro; iPad Series AirPods/Airpods Pro; Surface Pro 7/HP Stream 14"/Omen 17/Envy 13t/Spectre x360 13t; DELL Latitude 7380/XPS 13/16; ASUS ROG zephyrus G14/Zenbook13/14/15/flip 15/TUF A15/Vivobook 14/15/17

BASIC PARAMETER

Input: 100-240V~50/60Hz 1.8A Max
No-load power consumption: <0.3w

Size: 76*39*34mm
Weight: 150g

Average active efficiency: > 86.8%
Connector type: USB Type C, USB Type A

COLOR



FEATURES

[High-Efficiency with Multi USB Port Wall Charger] Powerful 33W PD output for exhilarating charging speeds. You can charge 4 devices simultaneously and conveniently.

[High Speed Charging] Fast charging saves your more time on charging you phone, you don't have to worry about your phone in low battery. (Note: Cable is not included)

[Multiple Protection & Reliable] Built-in over-charging, over-heating and short-circuit to protect your devices against excessive current. Maximum dual safety provide you safety experience.

[Portable and Compact] Foldable design save space to ensure maximum portability wherever you go. Efficient charging at home, in the office, or on the go.

[Highly Compatible] The Charger is compatible with Steam Deck/Laptops/Tablets/iPhone 14/14 Pro/14 Pro Max/13/12/Mini/ Pro/Pro Max/XS/ XS Max/XR/X/11/11 Pro/11 Pro max/8 Plus/8/7/6; Samsung Galaxy S Series/Note Series; LG V60/V50/G8/G7; Google Pixel Series; MacBook Air; MacBook Pro/MacBook/iPad Pro ;iPad Series Airpods/Airpods Pro; Surface Pro 7/HP Stream 14"/Omen 17/Envy 13t/Spectre x360 13t; DELL Latitude 7380/XPS 13/16; ASUS ROG zephyrus G14/Zenbook13/14/15/flip 15/TUF A15/Vivobook 14/15/17

[Note] Fast charging cable is requested for fast charging mode (Cable not included); It's recommended to use a standard USB-C to USB-C cable for Mackbook charging. When charging Samsung Galaxy S22+/S22 Ultra phones, the color of the charging ring pop-up will be different than when using an original fast charger, but the actual charging speed will be similar and you may see Super Fast Charging on your phone.

BASIC PARAMETER

Input: 100-240V~50/60Hz 0.8A
No-load power consumption: <0.075w

Size: 33.35*33.35*53.85mm
Weight: 46g

Average active efficiency: > 81.39%
Connector type: USB Type C, USB Type A

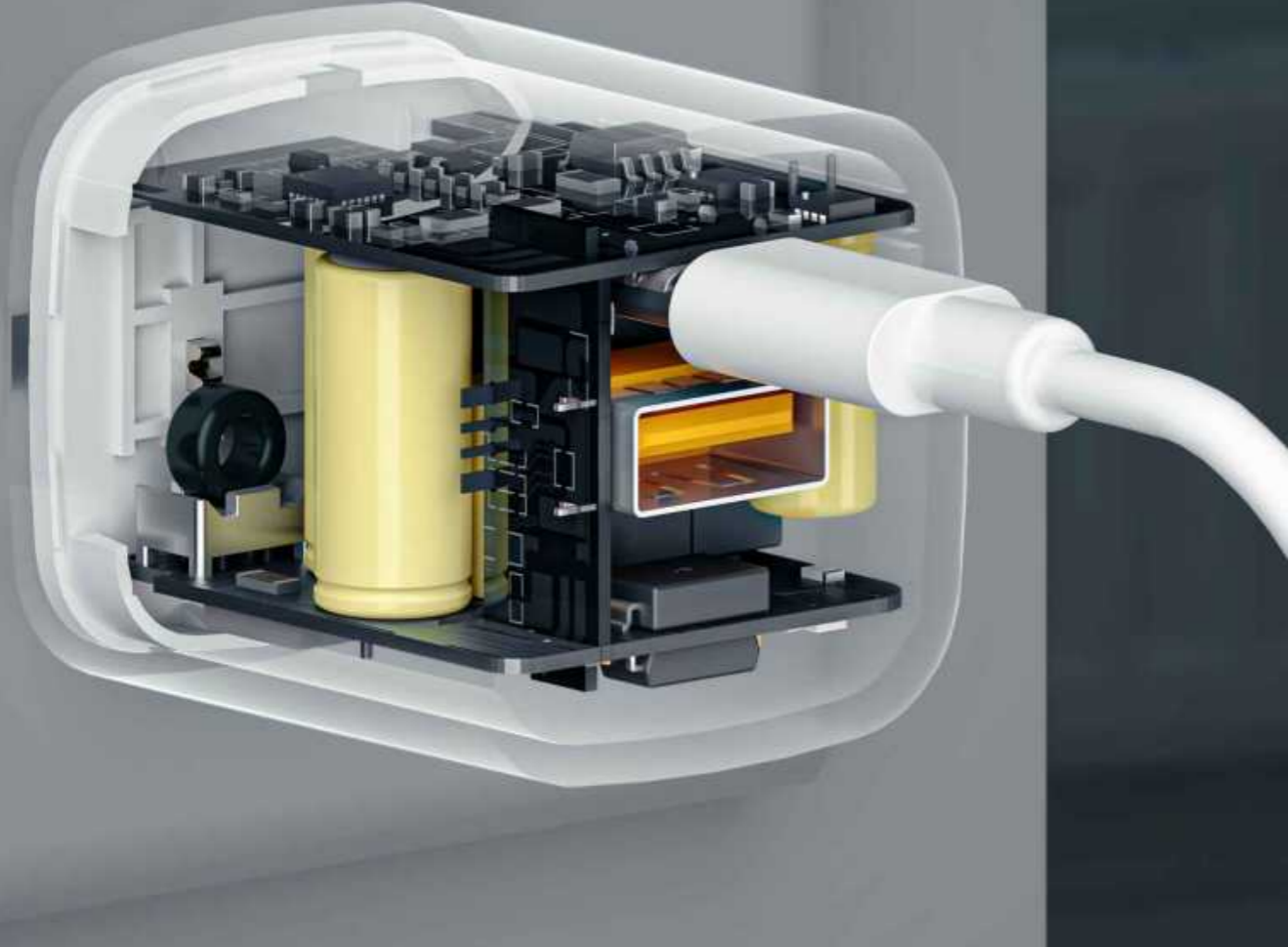

TOZO C3

33w GaN USB-C Wall Charger

GaN components waste less power and produce less heat, making the TOZO Wall Charger small but powerful.

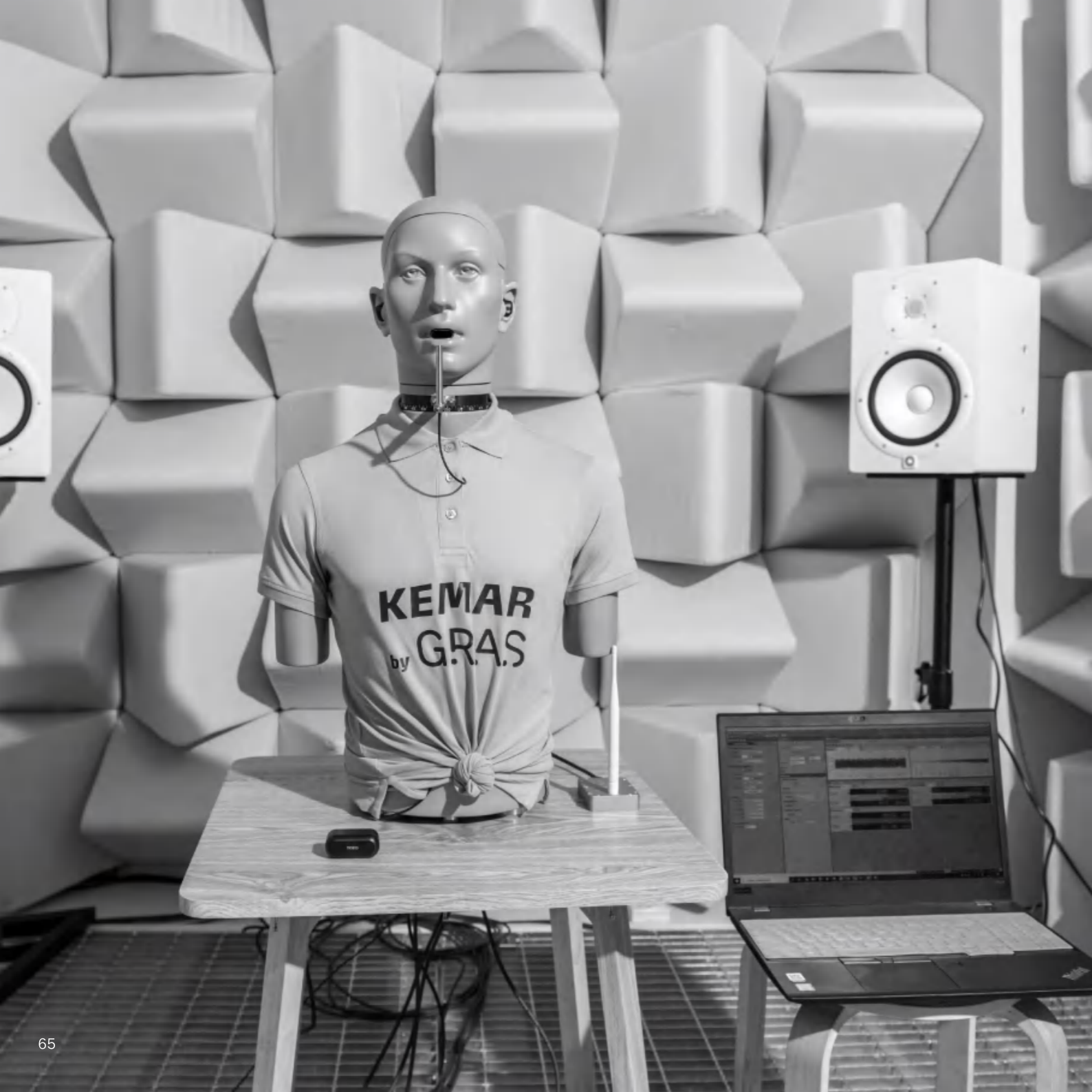

With sophisticated equipment, standardized production system, strict inspection and quality standards, TOZO provides consumers with more extreme experience.



In the construction of TOZO brand product displays and retail terminals, while focus on hardware construction such as product package, brand development, store layout and display environment, it also paying more attention to software construction of retail customers' communication and service capabilities. All to provide consumers with the most satisfied experience in purchasing.



Actively expand the global offline marketing network

In the implementation of the strategy, we work closely with major agents and distributors to achieve a win-win situation. Provide market-competitive products and services in a timely manner actively expand the global market.

